

Your step-by-step guide for COVID-19 self-testing



HM Government



Test and Trace

Read this whole guide carefully before you start the test.

This guide explains how to test yourself or another person for coronavirus (COVID-19), and report the results to the NHS.

Get more help at www.gov.uk/covid19-self-test-help including demonstration videos and instructions in alternative languages.

About this test

Many people with coronavirus (COVID-19) have mild, or even no symptoms, but can still spread the virus. With regular self-testing we can slow the spread and help protect the most vulnerable in our families and communities.

The Department of Health and Social Care (DHSC) COVID-19 Self-Test (Rapid Antigen Test) is a swab test to check for transmissible coronavirus (COVID-19).

How often you should test may vary depending on your circumstances and current national or local guidelines.

This test is suitable for the following people:

- **Adults aged 18+:** Self-test and report, with assistance if needed.
- **Adolescents aged 12 – 17:** Self-test and report with adult supervision. The adult may conduct the test as necessary.
- **Children under 12:** Children under 12 years of age should be tested by an adult. **Do not conduct this test if you do not feel confident testing a child.** Do not continue the test if the child feels any pain. **Please see page 10 for tips on how to test a child.**

Coronavirus (COVID-19) guidance and help

If you have coronavirus (COVID-19) symptoms or have contracted coronavirus (COVID-19), please refer to NHS guidance online:

www.nhs.uk/conditions/coronavirus-COVID-19

If you have symptoms of coronavirus (COVID-19) and your condition gets worse, or you do not get better after 7 days, use the NHS **111** online coronavirus service www.111.nhs.uk. If you do not have internet access, call NHS **111**. For a medical emergency dial **999**.

Do not delay getting help if you are worried. Trust your instincts.

General guidance and warnings

Use a separate test kit for each person. You can only use each item in the test kit once. Do not re-use the items. You'll need to report each person's result.

If you have problems with your hands or vision, you may need someone to assist you with the swabbing and testing process.

If you have a nose piercing, swab the other nostril. If pierced on both sides, remove the piercing on one side before swabbing.

If you've had a nosebleed within the last 24 hours, swab the other nostril or wait 24 hours.

Do not eat or drink for at least 30 minutes before doing the test to reduce the risk of spoiling the test.

These kits are only designed for human use.

By carefully following these instructions, you will ensure a reliable result is achieved.

Warning!

If there is a reason you cannot take a throat swab, for example you have a tracheostomy, instead swab both nostrils.

What you need to do

It's very important you read the instructions and follow the steps in the correct order. **Each test will take about 15 minutes to set up and results will be ready after a further 30 minutes.**

- 1 Prepare your test area and check your test kit contents: Page 5
- 2 Set up your test: Page 7
- 3 Take your swab sample: Page 9
- 4 Process the swab sample: Page 11
- 5 Read your result: Page 12
- 6 Report your result: Page 14
- 7 Safely dispose of your test kit: Page 17

Store the test kit at room temperature or in a cool dry place (2°C to 30°C). Do not leave in direct sunlight and do not store in a fridge or freezer.

The kit should be used at room temperature (15°C to 30°C). If the kit has been stored in a cool area (less than 15°C), leave it at normal room temperature for 30 minutes before using.

Keep the test kit away from children.

1. Prepare your test area and check your test kit contents

Warning!

Do not eat or drink for at least 30 minutes before doing the test to reduce the risk of spoiling the test.

Warning!

You'll need: a watch (or a clock), tissues, a mirror and either hand sanitiser or soap and warm water.

1 Read this instruction guide carefully.

See how to take the swab test by watching an online video at: www.gov.uk/covid19-self-test-help

2 Clear, clean and dry a flat surface immediately before starting the test.

3 Wash your hands thoroughly for 20 seconds, using soap and warm water, or hand sanitiser. This is so that you do not contaminate the test kit. Now dry your hands.

If doing more than one test, clean the surface and wash your hands again between each test.

4 Check the test kit contents. Make sure that nothing is damaged or broken.

Test strip in sealed packaging

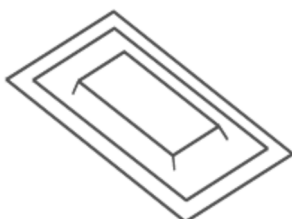

Swab inside sealed wrapper

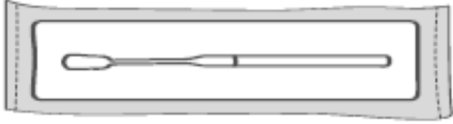

Extraction buffer sachet



Extraction tube

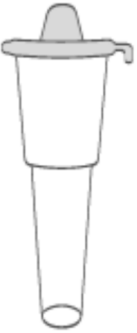

Extraction tube holder (attached to the box)

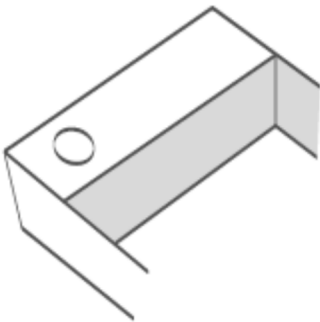

Waste bag

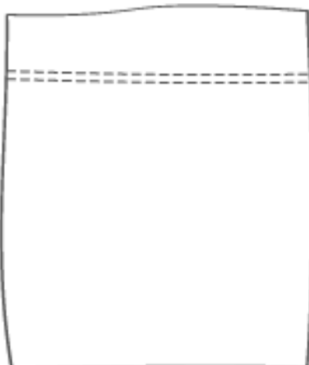

Warning!

Do not use the test strip if the sealed packaging is damaged.

Something damaged, broken or missing? If you notice anything damaged, broken, missing or difficult to use in the kit, do not use it. If you wish to provide feedback on this please call the customer contact centre. Lines open every day, 7am to 11pm.

- England, Wales, Northern Ireland: **119** (free from mobiles and landlines)
- Scotland: **0300 303 2713** (charged at your standard network rate)

If you've been harmed or had a reaction using this kit, report it on the Coronavirus Yellow Card Reporting Site:

<https://coronavirusyellowcard.mhra.gov.uk>

2. Set up your test

5 Take the test strip out of the sealed packaging and place it onto the cleaned flat surface. Once opened, start the test within 30 minutes.

Warning!

Safely throw away the inner desiccant bag and packaging in your household waste.

6 Carefully twist or snap open the sachet. Open it away from your face and be careful not to spill any of the liquid.

- 7 Open the extraction tube and gently squeeze all of the liquid from the buffer sachet into the tube.** Avoid touching the sachet against the tube.

Place extraction buffer sachet in the plastic waste bag provided.

- 8 Place the filled tube in the extraction tube holder (attached inside the box) to avoid spilling the liquid.**

You can also use a small cup to hold the tube.

- 9 Gently blow your nose into a tissue and throw the tissue away in a closed bin. If you are testing a child help them to blow their nose.** This is so that you get rid of excess mucus.

- 10 Wash your hands thoroughly again for 20 seconds using soap and warm water (or use sanitiser).**

If you're doing this test on another person, you should both wash or sanitise your hands again.

- 11 Find the swab in the sealed wrapper in front of you.** Identify the soft, fabric tip of the swab.

- 12 Peel open the swab packaging only when you are ready to use and gently take out the swab.** You'll use this for both throat and nose.

Warning!

Never touch the soft, fabric tip of the swab with your hands.

3. Take your swab sample

Warning!

Do not touch the tongue, teeth, cheeks, gums, or any other surfaces with the fabric tip of the swab. If it touches anything else, it may spoil your sample.

Never touch the fabric strip with your hands.

Taking the sample may cause gagging and minor discomfort, but it should not hurt.

If testing a child under 12, or a person who requires assistance, follow the steps on page 11

- 13 Holding the swab between your fingers, open your mouth wide and rub the fabric tip of the swab over both tonsils (or where they would have been). Do this with firm contact 4 times on each side** (use a torch or a mirror to help you do this). Carefully remove the swab from the back of your throat.
- 14 Put the same swab gently into 1 nostril until you feel a slight resistance** (about 2.5cm up your nose).

Roll the swab firmly around the inside of the nostril, making 10 complete circles.

This may feel uncomfortable. Do not insert the swab any deeper if you feel strong resistance or pain.

Testing a child

Children under 12 should be tested by an adult. Follow the guidelines below on how to prepare and test a child. You can watch a demonstration video at www.gov.uk/covid19-self-test-help

Show the child the test kit and talk to them about what you are going to do. If possible, sit them on someone's lap or have someone hold their hand.

Ask the child to blow their nose and cough into a tissue. Throw the tissue away in a closed bin. Ask the child to open their mouth as wide as they can and say 'Ahhhh' (this will make the tonsils easier to see) for as long as they can while you swab their tonsils (or where their tonsils would be if they have been removed).

13 Hold the swab in your hand, ask the child to open their mouth wide and tilt their head back. Gently rub the fabric tip of the swab over both tonsils (or where they would have been). Do this with firm contact 4 times on each side. Carefully remove the swab.

14 Put the fabric tip of the same swab gently into 1 of their nostrils until you feel some resistance. Roll the swab firmly around the inside of the nostril, making 10 complete circles and slowly remove it.

If you did not swab the tonsils, swab both nostrils, making 10 complete circles in each nostril.

You can get more advice about COVID-19 in children at:
www.nhs.uk/conditions/coronavirus-covid-19/symptoms/coronavirus-in-children/

4. Process the swab sample

15 Pick up the extraction tube and place the fabric tip of the swab into the extraction tube so it is in the liquid.

Press the tip against the edge of the extraction tube with force, while rotating it around the extraction tube for 15 seconds. This is to transfer your sample into the liquid.

16 **Pinch the extraction tube against the swab as you remove it. Make sure you remove all liquid from the soft tip of the swab.**

Place the swab in the plastic waste bag provided.

17 **Press the cap tightly on to the extraction tube to avoid any leaks.**

18 **Gently squeeze the extraction tube to place 2 drops of the liquid onto the specimen well (S) on the test strip.** Make sure that you are dropping liquid and not an air bubble.

Put the extraction tube in the plastic waste bag along with the swab.

Warning!

Make sure you place the test strip on a flat and level surface. Do not move the strip during the test.

19 **Check the time and set a timer if you have one. Wait 30 minutes before you read your result.**

Waiting the full 30-minute development time before you read your result is very important.

A positive result can appear at any time after 20 minutes, however you must wait for the full 30 minutes to record a negative result as the test line (T) may take this long to appear.

Find out how to read and report your result below.

5. Read your result

You will see the control line (C) begin to appear after about 4 minutes. You must wait 30 minutes before your result is ready.

Warning!

Do not leave the test to develop for longer than 30 minutes as this will make the result void.

Negative result

One line next to C shows the test is negative.

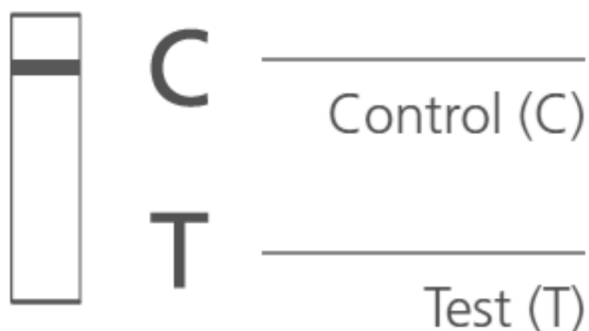

Positive result



Two lines, one next to C and one next to T, even faint lines, shows the test is positive. You must report this test result to the NHS, please see **page 14** for guidance on how to do this.

Warning!

If your test result is positive, you and your household must self-isolate following Government guidelines.

Void result

No lines or one line next to T means the test is void.



Report your results to get the guidance you need to follow (see page 14).

6. Report your result

You must report your results to the NHS.

Report your result so the NHS can monitor the spread of the virus, support communities across the UK, combat the virus and save lives. You can also find out more about the result and what you need to do.

You need the QR code, or the ID number under it, on the test strip to report your result.

Report online (fastest)

Visit: www.gov.uk/report-covid19-result

Or report by telephone

Lines are open every day, 7am to 11pm.

England, Wales and Northern Ireland: **119**
(free from mobiles and landlines)

Scotland: **0300 303 2713**
(charged at your standard network rate)

What your results mean

Positive result

If you get a **positive result**, it means you are currently infected with coronavirus and risk infecting others. When you report your result, you will be provided with further information on the next steps to take.

Please note, your results will be identified as an LFD (Lateral Flow Device) result on the text message you will receive.

Warning!

You, anyone who lives with you, and anyone in your support bubble, must self-isolate in accordance with current national and local guidance, which can be found at www.nhs.uk/conditions/coronavirus-covid-19/self-isolation-and-treatment/

Negative result

If you get a **negative result**, it is likely that you were not infectious at the time the test was taken. A negative test result, however, is not a guarantee that you do not have coronavirus.

If you test negative, you **must** continue to follow national and local rules and guidelines including regular handwashing, social distancing and wearing face coverings, where required.

If you develop symptoms of a high temperature, a new, continuous cough or a loss or change to your sense of taste or smell you and your household must self-isolate and get another test at www.gov.uk/get-coronavirus-test or by calling the customer contact centre. Lines open every day, 7am to 11 pm.

- England, Wales, Northern Ireland: **119** (free from mobiles and landlines)
- Scotland: **0300 303 2713** (charged at your standard network rate)

Void result

If you get a **void result**, this means that the test has not run correctly. You need to take another test. Use a new test kit, but do not reuse anything from the first kit.

If you do not have another test available, you may take a different type of test through the NHS COVID-19 app, or by visiting www.gov.uk/get-coronavirus-test or by calling the customer contact centre. Lines open every day, 7am to 11pm.

- England, Wales, Northern Ireland: **119** (free from mobiles and landlines)
- Scotland: **0300 303 2713** (charged at your standard network rate)

Test performance

The test is more likely to give a positive result if someone has high levels of coronavirus (COVID-19).

This means that it is most likely to detect the people who are currently infectious and need to immediately self-isolate.

7. Safely dispose of your test kit

Once your test is complete, **put all of the used test kit contents in the waste bag provided.** Put in your general household waste.

Make a note of your test results

This is for your own records. You must still report your result to the NHS (see page 14 for information).

| | |
|--------------------|--|
| Who took the test: | |
| Date: | |
| Time: | |
| Test result: | |

| | |
|--------------------|--|
| Who took the test: | |
| Date: | |
| Time: | |
| Test result: | |

| | |
|--------------------|--|
| Who took the test: | |
| Date: | |
| Time: | |
| Test result: | |

| | |
|--------------------|--|
| Who took the test: | |
| Date: | |
| Time: | |
| Test result: | |

| | |
|--------------------|--|
| Who took the test: | |
| Date: | |
| Time: | |
| Test result: | |

| | |
|--------------------|--|
| Who took the test: | |
| Date: | |
| Time: | |
| Test result: | |

| | |
|--------------------|--|
| Who took the test: | |
| Date: | |
| Time: | |
| Test result: | |

| | |
|--------------------|--|
| Who took the test: | |
| Date: | |
| Time: | |
| Test result: | |

| | |
|--------------------|--|
| Who took the test: | |
| Date: | |
| Time: | |
| Test result: | |

| | |
|--------------------|--|
| Who took the test: | |
| Date: | |
| Time: | |
| Test result: | |

Your kit contains the following materials

- **Item:** Instructions for use (this document)
3-Pack: 1
7-Pack: 1
- **Item:** Extraction tube holder
3-Pack: 1
7-Pack: 1
- **Item:** Test strips in sealed packaging
3-Pack: 3
7-Pack: 7
- **Item:** Extraction buffer sachets
3-Pack: 3
7-Pack: 7
- **Item:** Extraction tubes
3-Pack: 3
7-Pack: 7
- **Item:** Swabs inside sealed wrapper
3-Pack: 3
7-Pack: 7
- **Item:** Waste bags
3-Pack: 3
7-Pack: 7

Supply of this device is only permitted as part of the DHSC deployment under the NHS Test and Trace programme.

Manufacturer: Department of Health and Social Care, 39 Victoria Street, Westminster, London, SW1 0EU.

Manufactured under contract to DHSC by: Xiamen Biotime Biotechnology Co Ltd, 2F/3F/4F, No. 188, Pingcheng South Road, Haicang Street, Haicang District, Xiamen, Fujian, 361026, P. R. China.

Index of symbols

Store at 2 – 30°C

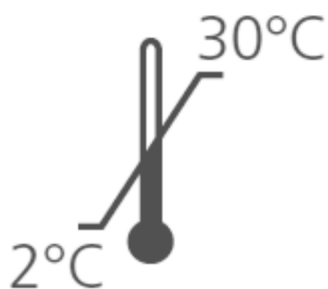

Lot number



Keep away from sunlight



Keep dry



Sterilized using ethylene oxide



Expiry date



Date of manufacture



Consult instructions for use



Manufacturer



In vitro diagnostic medical device



Do not re-use



Don't use the product when the package is damaged



Warning, please refer to the instruction



All of the information and images in this document are correct as of 15th January 2021.

Version 1.3.1